

Approval body for construction products  
and types of construction

Bautechnisches Prüfamt

An institution established by the Federal and  
Laender Governments



## European Technical Assessment

ETA-13/0364  
of 7 May 2015

English translation prepared by DIBt - Original version in German language

### General Part

Technical Assessment Body issuing the  
European Technical Assessment:

Deutsches Institut für Bautechnik

Trade name of the construction product

JCP Option 1 Throughbolt and Option 1 Throughbolt ITS

Product family  
to which the construction product belongs

Torque controlled expansion anchor for use  
in concrete

Manufacturer

Hexstone Ltd. T/A JCP Construction Products  
Opal Way  
Stone Business Park, Stone  
Staffordshire ST 15 0SW .  
GROSSBRITANNIEN

Manufacturing plant

Plant 2, Germany

This European Technical Assessment  
contains

32 pages including 3 annexes which form an integral part  
of this assessment

This European Technical Assessment is  
issued in accordance with Regulation (EU)  
No 305/2011, on the basis of

Guideline for European technical approval of "Metal  
anchors for use in concrete", ETAG 001 Part 2: "Torque  
controlled expansion anchors", April 2013,  
used as European Assessment Document (EAD)  
according to Article 66 Paragraph 3 of Regulation (EU)  
No 305/2011.

The European Technical Assessment is issued by the Technical Assessment Body in its official language. Translations of this European Technical Assessment in other languages shall fully correspond to the original issued document and shall be identified as such.

Communication of this European Technical Assessment, including transmission by electronic means, shall be in full. However, partial reproduction may only be made with the written consent of the issuing Technical Assessment Body. Any partial reproduction has to be identified as such.

This European Technical Assessment may be withdrawn by the issuing Technical Assessment Body, in particular pursuant to information by the Commission according to Article 25 Paragraph 3 of Regulation (EU) No 305/2011.

## Specific Part

### 1 Technical description of the product

The JCP Option 1 Throughbolt and Option 1 Throughbolt ITS is an anchor made of galvanised steel or made of stainless steel or high corrosion resistant steel which is placed into a drilled hole and anchored by torque-controlled expansion. The following anchor types are covered:

- Anchor type Option 1 Throughbolt with external thread, washer and hexagon nut, sizes M8 to M27,
- Anchor type Option 1 Throughbolt ITS S with internal thread, hexagon head nut and washer S-IG, sizes M6 to M12,
- Anchor type Option 1 Throughbolt ITS SK with internal thread, countersunk head screw and countersunk washer SK-IG, sizes M6 to M12,
- Anchor type Option 1 Throughbolt ITS B with internal thread, hexagon nut and washer MU-IG, sizes M6 to M12.

The product description is given in Annex A.

### 2 Specification of the intended use in accordance with the applicable European Assessment Document

The performances given in Section 3 are only valid if the anchor is used in compliance with the specifications and conditions given in Annex B.

The verifications and assessment methods on which this European Technical Assessment is based lead to the assumption of a working life of the anchor of at least 50 years. The indications given on the working life cannot be interpreted as a guarantee given by the producer, but are to be regarded only as a means for choosing the right products in relation to the expected economically reasonable working life of the works.

### 3 Performance of the product and references to the methods used for its assessment

#### 3.1 Mechanical resistance and stability (BWR 1)

Essential characteristic	Performance
Characteristic resistance for static and quasi static action for Option 1 Throughbolt	See Annex C 1 to C 5
Characteristic resistance for seismic performance categories C1 and C2 for Option 1 Throughbolt	See Annex C 6
Characteristic resistance for static and quasi static action for Option 1 Throughbolt ITS	See Annex C 10 to C 12
Displacements under tension loads for Option 1 Throughbolt	See Annex C 8
Displacements under shear loads for Option 1 Throughbolt	See Annex C 9
Displacements under tension and shear loads for Option 1 Throughbolt ITS	See Annex C 14

English translation prepared by DIBt

### 3.2 Safety in case of fire (BWR 2)

Essential characteristic	Performance
Reaction to fire	Anchorage satisfy requirements for Class A1
Resistance to fire for Option 1 Throughbolt	See Annex C 7
Resistance to fire for Option 1 Throughbolt ITS	See Annex C 13

### 3.3 Hygiene, health and the environment (BWR 3)

Not applicable.

### 3.4 Safety in use (BWR 4)

The essential characteristics regarding Safety in use are included under the Basic Works Requirement Mechanical resistance and stability.

### 3.5 Protection against noise (BWR 5)

Not applicable.

### 3.6 Energy economy and heat retention (BWR 6)

Not applicable.

### 3.7 Sustainable use of natural resources (BWR 7)

The sustainable use of natural resources was not investigated.

### 3.8 General aspects

The verification of durability is part of testing the essential characteristics. Durability is only ensured if the specifications of intended use according to Annex B are taken into account.

## 4 Assessment and verification of constancy of performance (AVCP) system applied, with reference to its legal base

According to Decision of the Commission of 24 June 1996 (96/582/EC) (OJ L 254 of 08.10.96 p. 62-65), the system of assessment and verification of constancy of performance (see Annex V and Article 65 Paragraph 2 to Regulation (EU) No 305/2011) given in the following table applies.

Product	Intended use	Level or class	System
Metal anchors for use in concrete (heavy-duty type)	For fixing and/or supporting concrete structural elements or heavy units such as cladding and suspended ceilings	—	1

English translation prepared by DIBt

**5 Technical details necessary for the implementation of the AVCP system, as provided for in the applicable European Assessment Document**

Technical details necessary for the implementation of the AVCP system are laid down in the control plan deposited at Deutsches Institut für Bautechnik.

Issued in Berlin on 7 May 2015 by Deutsches Institut für Bautechnik

Uwe Bender  
Head of Department

*beglaubigt:*  
Baderschneider

### Option 1 Throughbolt

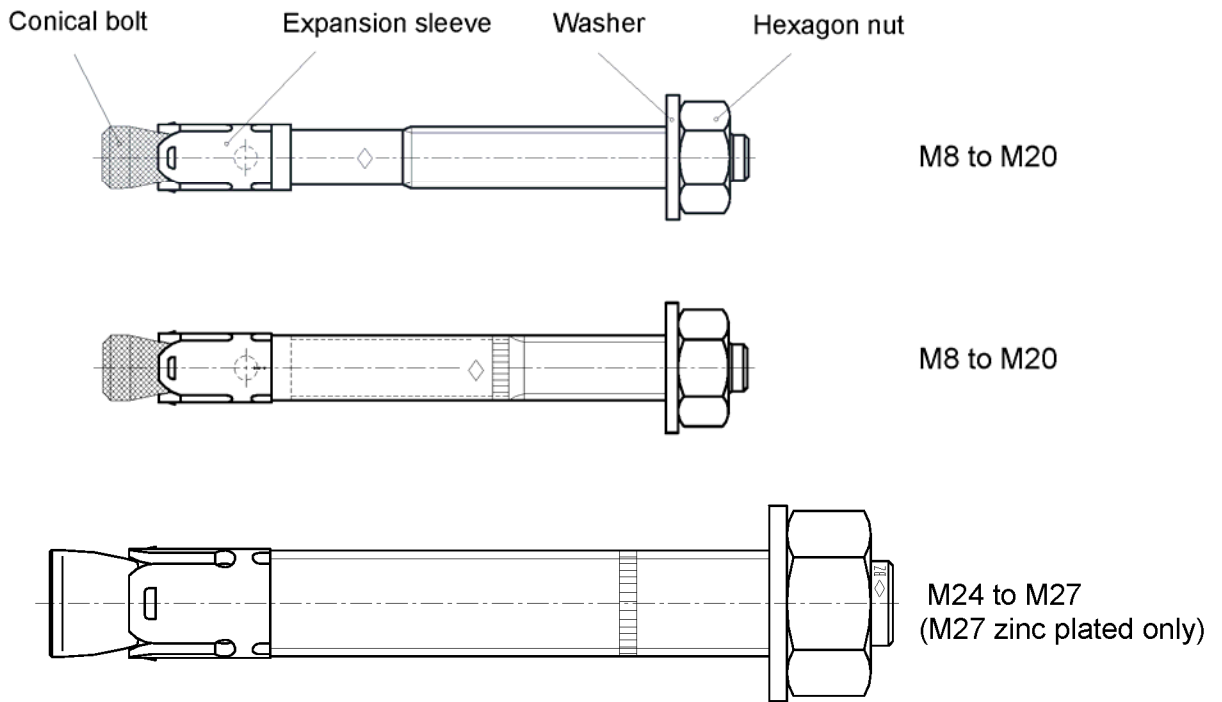

### Option 1 Throughbolt ITS M6 to M12

#### Anchor system

<b>Option 1 Throughbolt ITS S</b>		Washer	Hexagon head screw
<b>Option 1 Throughbolt ITS SK</b>	Conical bolt	Countersunk washer	Countersunk head screw
<b>Option 1 Throughbolt ITS B</b>	Expansion sleeve	Washer Hexagon nut	Commercial standard rod

Anchor version	Product description	Intended use	Performance
<b>Option 1 Throughbolt</b>	Annex A1 – Annex A4	Annex B1 – Annex B4	Annex C1 – Annex C9
<b>Option 1 Throughbolt ITS</b>	Annex A1 – Annex A2 Annex A5 – Annex A6	Annex B1 Annex B5 – Annex B7	Annex C10 – Annex C14

### JCP Option 1 Throughbolt and Option 1 Throughbolt ITS

Product description  
Anchor types

**Annex A1**

**Intended use Option 1 Throughbolt**

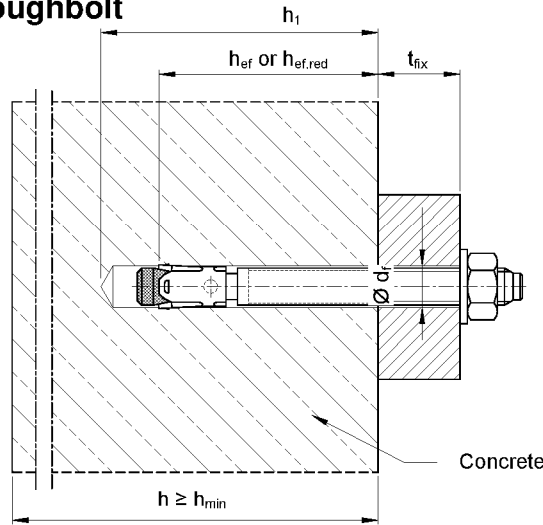

**Intended use Option 1 Throughbolt ITS**

**Installation type V  
pre-setting installation**

pre-set anchor body, the fixture bears on the screw or thread rod only

**Option 1 Throughbolt ITS S** consisting of Option 1 Throughbolt ITS and S-IG

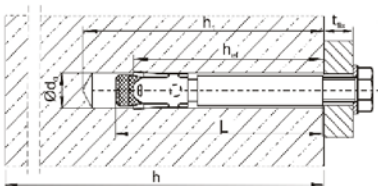

**Option 1 Throughbolt ITS SK** consisting of Option 1 Throughbolt ITS and SK-IG

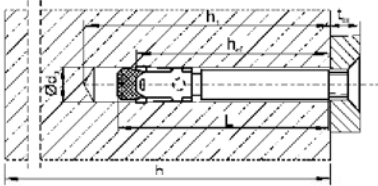

**Option 1 Throughbolt ITS B** consisting of Option 1 Throughbolt ITS and MU-IG

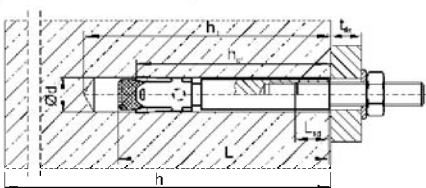

**Installation type D  
through-setting installation**

the anchor is set through the fixture, the fixture bears on the conical bolt Option 1 Throughbolt ITS

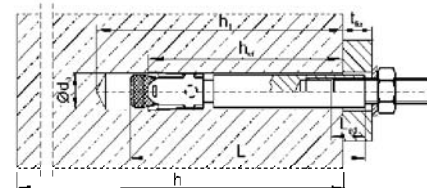
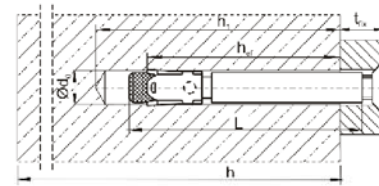
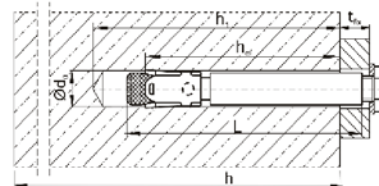

**JCP Option 1 Throughbolt and Option 1 Throughbolt ITS**

Product description  
Installation situation

**Annex A2**

**Anchor size Option 1 Throughbolt M8 to M20:**

Marking 1 e.g.:  $\diamond$  BZ 15/35

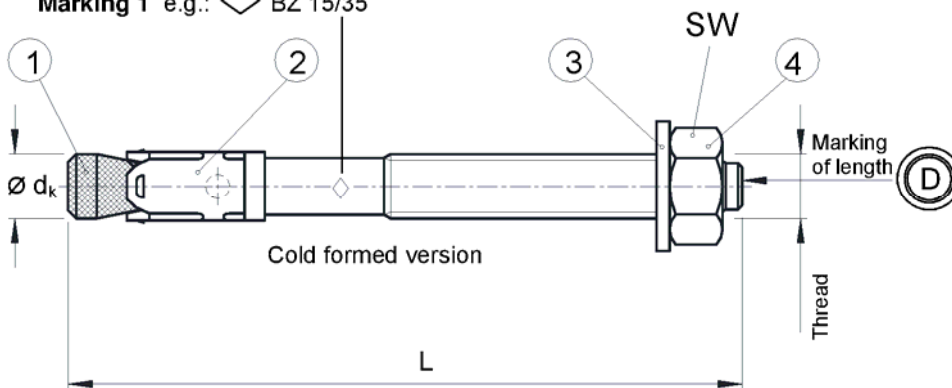

Marking 1: e.g.:  $\diamond$  BZ 15/35

- $\diamond$  Identifying mark of manufacturing plant
- BZ Trade name
- 15 maximum thickness of fixture for  $h_{ef}$
- 35 max. thickness of fixture for  $h_{ef,red}$
- A4 additional marking of stainless steel A4
- HCR additional marking of high corrosion resistant steel HCR

Marking 2 e.g.:  $\diamond$  BZ 15

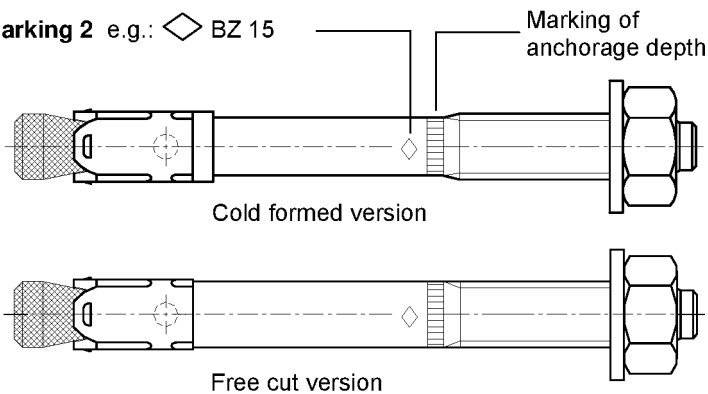

Marking 2: e.g.:  $\diamond$  BZ 15

- $\diamond$  Identifying mark of manufacturing plant
- BZ Trade name
- 15 maximum thickness of fixture for  $h_{ef}$
- A4 additional marking of stainless steel A4
- HCR additional marking of high corrosion resistant steel HCR

**Anchor size Option 1 Throughbolt M24 and M27:**

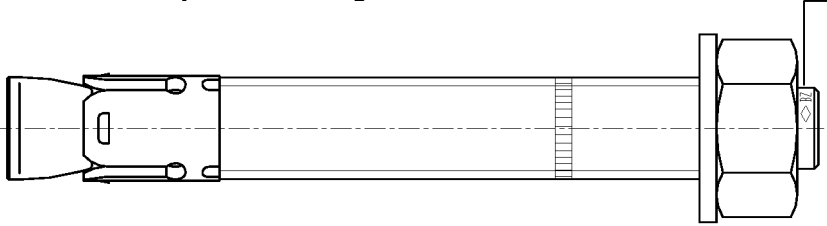

Marking 3: e.g.:  $\diamond$  BZ M24-30

- $\diamond$  Identifying mark of manufacturing plant
- BZ Trade name
- M24 Thread diameter
- 30 maximum thickness of fixture
- A4 additional marking of stainless steel A4

Marking of length	C (c)	D (d)	E (e)	F (f)	G (g)	H (h)	I (i)	J (j)	K (k)	L (l)	M (m)	N (n)
Length of anchor min $\geq$	63,5	76,2	88,9	101,6	114,3	127,0	139,7	152,4	165,1	177,8	190,5	203,2
Length of anchor max $<$	76,2	88,9	101,6	114,3	127,0	139,7	152,4	165,1	177,8	190,5	203,2	215,9

Marking of length	O (o)	P (p)	Q (q)	R (r)	S (s)	T (t)	U (u)	V (v)	W (w)	X (x)	Y (y)	Z (z)
Length of anchor min $\geq$	215,9	228,6	241,3	254,0	279,4	304,8	330,2	355,6	381,0	406,4	431,8	457,2
Length of anchor max $<$	228,6	241,3	254,0	279,4	304,8	330,2	355,6	381,0	406,4	431,8	457,2	483,0

**JCP Option 1 Throughbolt**

Product description  
Anchor sizes and marking

**Annex A3**



**Table A1: Anchor dimensions Option 1 Throughbolt**

Anchor size			M8	M10	M12	M16	M20	M24	M27	
1	Conical bolt	Thread	M8	M10	M12	M16	M20	M24	M27	
		$\varnothing d_k =$	7,9	9,8	12,0	15,7	19,7	24	28	
	Length of anchor	Steel, zinc plated	L	65 + t <sub>fix</sub>	80 + t <sub>fix</sub>	96,5+t <sub>fix</sub>	118+t <sub>fix</sub>	137+t <sub>fix</sub>	161+t <sub>fix</sub>	178+t <sub>fix</sub>
		A4, HCR	L	65 + t <sub>fix</sub>	80 + t <sub>fix</sub>	96,5+t <sub>fix</sub>	118+t <sub>fix</sub>	137+t <sub>fix</sub>	168+t <sub>fix</sub>	
	red. anchorage depth	L <sub>hef,red</sub>	54 + t <sub>fix</sub>	60 + t <sub>fix</sub>	76,5+t <sub>fix</sub>	98+t <sub>fix</sub>				
2	Expansion sleeve		see Table A2							
3	Washer		see Table A2							
4	Hexagon nut	SW	13	17	19	24	30	36	41	

Dimensions in mm

**Table A2: Materials Option 1 Throughbolt**

No.	Part	Steel, zinc plated M8 to M20	Steel, zinc plated M24 and M27	Stainless steel A4	High corrosion resistant steel (HCR)
1	Conical bolt	Cold formed or machined steel, Cone plastic coated (M8 to M20)	Threaded bolt and threaded cone, steel	Stainless steel 1.4401, 1.4404, 1.4571 or 1.4578, EN 10088:2005, Cone plastic coated	High corrosion resistant steel 1.4529 or 1.4565, EN 10088:2005, Cone plastic coated
2	Expansion sleeve	Steel acc. to EN 10088:2005, material No. 1.4301 or 1.4401	Steel acc. to EN 10139-12:1997	Stainless steel 1.4401 or 1.4571, EN 10088:2005	Stainless steel 1.4401 or 1.4571, EN 10088:2005
3	Washer	Steel, galvanised		Stainless steel 1.4401 or 1.4571, EN 10088:2005	High corrosion resistant steel 1.4529 or 1.4565, EN 10088:2005
4	Hexagon nut	Steel, galvanised, coated		stainless steel 1.4401 or 1.4571, EN 10088:2005, coated	high corrosion resistant steel 1.4529 or 1.4565, EN 10088:2005, coated

**JCP Option 1 Throughbolt**

Product description  
Dimensions and materials

**Annex A4**

**Marking:**  $\diamond$  Identifying mark of manufacturing plant  
 BZ Trade name  
 M6 Size of internal thread  
 10 max. thickness of fixture  
 (only installation type D)  
 A4 additionally for stainless steel  
 HCR additionally for high corrosion resistant steel

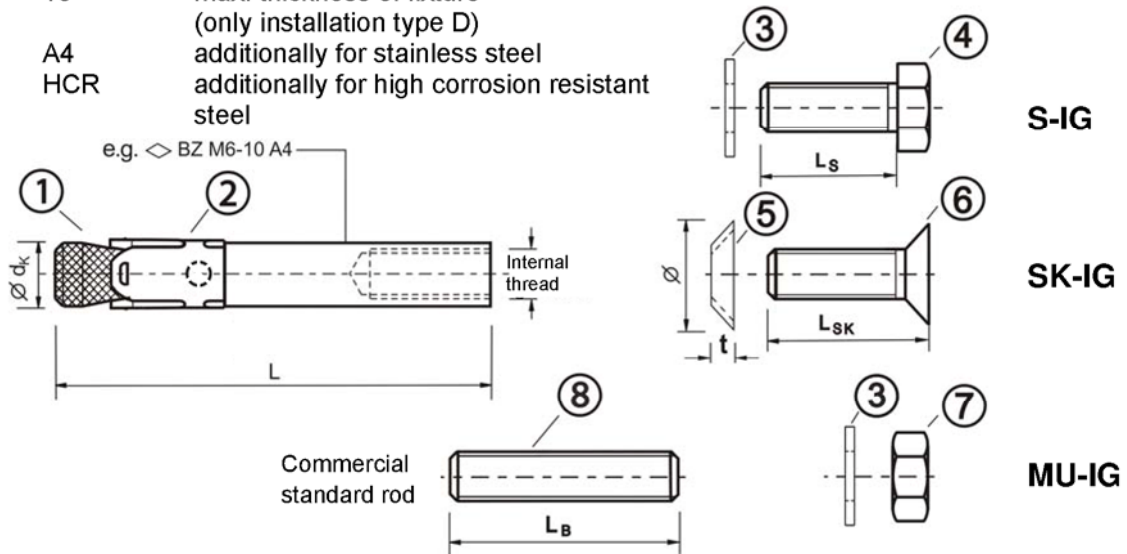

**Table A3: Anchor dimensions Option 1 Throughbolt ITS**

No.	Anchor size		M6	M8	M10	M12	
1	Conical bolt with Internal thread Installation type V Installation type D	$\varnothing d_k$	7,9	9,8	11,8	15,7	
		L	50	62	70	86	
		L	50 + t <sub>fix</sub>	62 + t <sub>fix</sub>	70 + t <sub>fix</sub>	86 + t <sub>fix</sub>	
2	Expansion sleeve	see table A4					
3	Washer	see table A4					
4	Hexagon head screw Installation type V Installation type D	width across flats	10	13	17	19	
		L <sub>S</sub>	t <sub>fix</sub> + (13 to 21)	t <sub>fix</sub> + (17 to 23)	t <sub>fix</sub> + (21 to 25)	t <sub>fix</sub> + (24 to 29)	
		L <sub>S</sub>	14 to 20	18 to 22	20 to 22	25 to 28	
5	Countersunk washer	$\varnothing$ countersink	17,3	21,5	25,9	30,9	
		t	3,9	5,0	5,7	6,7	
6	Countersunk head screw	bit size	Torx T30	Torx T45 (Steel, zinc plated) T40 (Stainless steel A4, HCR)	Hexagon socket 6 mm	Hexagon socket 8 mm	
		L <sub>SK</sub>	t <sub>fix</sub> + (11 to 19)	t <sub>fix</sub> + (15 to 21)	t <sub>fix</sub> + (19 to 23)	t <sub>fix</sub> + (21 to 27)	
		L <sub>SK</sub>	16 to 20	20 to 25	25	30	
7	Hexagon nut	width across flats	10	13	17	19	
8	Commercial standard rod <sup>1)</sup>	type V	L <sub>B</sub> ≥	t <sub>fix</sub> + 21	t <sub>fix</sub> + 28	t <sub>fix</sub> + 34	t <sub>fix</sub> + 41
		type D	L <sub>B</sub> ≥	21	28	34	41

<sup>1)</sup> acc. to specifications (Table A4)

Dimensions in mm

**JCP Option 1 Throughbolt ITS**

**Product description**  
Anchor parts, marking and dimensions

**Annex A5**

**Table A4: Materials Option 1 Throughbolt ITS**

No.	Part	Steel, zinc plated ≥ 5 µm acc. to EN ISO 4042:1999	Stainless steel A4	High corrosion resistant steel HCR
1	Conical bolt Option 1 Throughbolt ITS with internal thread	Machined steel, Cone plastic coated	Stainless steel, 1.4401, 1.4404, 1.4571, 1.4362, EN 10088:2005, Cone plastic coated	High corrosion resistant steel, 1.4529, 1.4565, EN 10088:2005, Cone plastic coated
2	Expansion sleeve Option 1 Throughbolt ITS	Stainless steel, 1.4301, 1.4401, EN 10088:2005	Stainless steel, 1.4401, 1.4571, EN 10088:2005	Stainless steel, 1.4401, 1.4571, EN 10088:2005
3	Washer S-IG / MU-IG	Steel, galvanised	Stainless steel, 1.4401, 1.4571, EN 10088:2005	High corrosion resistant steel, 1.4529, 1.4565, EN 10088:2005
4	Hexagon head screw S-IG	Steel, galvanised, coated	Stainless steel, 1.4401, 1.4571, EN 10088:2005, coated	High corrosion resistant steel, 1.4529, 1.4565, EN 10088:2005, coated
5	Countersunk washer SK-IG	Steel, galvanised	Stainless steel, 1.4401, 1.4404, 1.4571, EN 10088:2005, zinc plated, coated	High corrosion resistant steel, 1.4529, 1.4565, EN 10088:2005, zinc plated, coated
6	Countersunk head screw SK-IG	Steel, galvanised coated	Stainless steel, 1.4401, 1.4571, EN 10088:2005, coated	High corrosion resistant steel, 1.4529, 1.4565, EN 10088:2005, coated
7	Hexagon nut MU-IG	Steel, galvanised coated	Stainless steel, 1.4401, 1.4571, EN 10088: 2005, coated	High corrosion resistant steel, 1.4529, 1.4565, EN 10088:2005, coated
8	Commercial standard rod	Property class 8.8, EN ISO 898-1:2013 A <sub>5</sub> > 8 % ductile	Stainless steel, 1.4401, 1.4571, EN 10088:2005, property class 70, EN ISO 3506:2009	High corrosion resistant steel, 1.4529, 1.4565, EN 10088:2005, property class 70, EN ISO 3506:2009

**JCP Option 1 Throughbolt ITS**

**Product description**  
Materials

**Annex A6**

### Specifications of intended use

Option 1 Throughbolt	M8	M10	M12	M16	M20	M24	M27
Static or quasi-static action				✓			
Seismic action (Categorie C1 + C2) <sup>1) 2)</sup>		✓	✓	✓	✓		
Reduced anchorage depth <sup>2)</sup>	✓	✓	✓	✓			
Fire exposure <sup>1)</sup>				✓			
Cracked and non-cracked				✓			

Option 1 Throughbolt ITS	M6	M8	M10	M12
Static or quasi-static action		✓		
Seismic action				
Fire exposure		✓		
Cracked and non-cracked		✓		

<sup>1)</sup> only for standard anchorage depth

<sup>2)</sup> only cold formed anchors acc. to Annex A3

#### Base materials:

- Reinforced or unreinforced normal weight concrete according to EN 206-1: 2000
- Strength classes C20/25 to C50/60 according to EN 206-1: 2000

#### Use conditions (Environmental conditions):

- Structures subject to dry internal conditions (zinc plated steel, stainless steel or high corrosion resistant steel).
- Structures subject to external atmospheric exposure including industrial and marine environment or exposure to permanently damp internal condition, if no particular aggressive conditions exist (stainless steel or high corrosion resistant steel).
- Structures subject to external atmospheric exposure and to permanently damp internal condition, if other particular aggressive conditions (high corrosion resistant steel)

Note: Particular aggressive conditions are e.g. permanent, alternating immersion in seawater or the splash zone of seawater, chloride atmosphere of indoor pools or atmosphere with extreme chemical pollution (e.g. in desulphurization plants or road tunnels where de-icing materials are used.)

#### Design:

- Anchorages are designed under the responsibility of an engineer experienced in anchorages and concrete work.
- Verifiable calculation notes and drawings are prepared taking account of the loads to be anchored. The position of the anchor is indicated on the design drawings (e.g. position of the anchor relative to reinforcement or to supports, etc.).
- Anchorages under static or quasi-static actions are designed in accordance with:
  - ETAG 001, Annex C, design method A, Edition August 2010 or
  - CEN/TS 1992-4: 2009, design method A
- Anchorages under seismic actions (cracked concrete) are designed in accordance with:
  - EOTA Technical Report TR 045, Edition February 2013
  - Anchorages shall be positioned outside of critical regions (e.g. plastic hinges) of the concrete structure
  - Fastenings in stand-off installation or with a grout layer are not allowed
- Anchorages under fire exposure are designed in accordance with:
  - EOTA Technical Report TR 020, Edition May 2004
  - CEN/TS 1992-4: 2009, Annex D
 (It must be ensured that local spalling of the concrete cover does not occur)

### JCP Option 1 Throughbolt and Option 1 Throughbolt ITS

Intended use  
Specifications

Annex B1

**Table B1: Installation parameters Option 1 Throughbolt**

Anchor size			M8	M10	M12	M16	M20	M24	M27	
Nominal drill hole diameter	$d_0$	[mm]	8	10	12	16	20	24	28	
Cutting diameter of drill bit	$d_{cut} \leq$	[mm]	8,45	10,45	12,5	16,5	20,55	24,55	28,55	
Installation torque	Steel, zinc plated	$T_{inst}$	20	25	45	90	160	200	300	
	A4, HCR	$T_{inst}$	20	35	50	110	200	290		
Diameter of clearance hole in the fixture	$d_f \leq$	[mm]	9	12	14	18	22	26	30	
<b>Standard anchorage depth</b>										
Depth of drill hole	Steel, zinc plated	$h_1 \geq$	[mm]	60	75	90	110	125	145	160
	A4, HCR	$h_1 \geq$	[mm]	60	75	90	110	125	155	
Effective anchorage depth	Steel, zinc plated	$h_{ef}$	[mm]	46	60	70	85	100	115	125
	A4, HCR	$h_{ef}$	[mm]	46	60	70	85	100	125	
<b>Reduced anchorage depth</b>										
Depth of drill hole	$h_{1,red} \geq$	[mm]	49	55	70	90				
Reduced effective anchorage depth	$h_{ef,red}$	[mm]	35	40	50	65				

**Table B2: Minimum spacings and edge distances, reduced anchorage depth, Option 1 Throughbolt**

Anchor size			M8	M10	M12	M16
Minimum thickness of concrete member	$h_{min,3}$	[mm]	80	80	100	140
<b>Cracked concrete</b>						
Minimum spacing	$s_{min}$	[mm]	50	50	50	65
	for $c \geq$	[mm]	60	100	160	170
Minimum edge distance	$c_{min}$	[mm]	40	65	65	100
	for $s \geq$	[mm]	185	180	250	250
<b>Non-cracked concrete</b>						
Minimum spacing	$s_{min}$	[mm]	50	50	50	65
	for $c \geq$	[mm]	60	100	160	170
Minimum edge distance	$c_{min}$	[mm]	40	65	100	170
	for $s \geq$	[mm]	185	180	185	65

**JCP Option 1 Throughbolt**

**Intended use**  
Installation parameters,  
Minimum spacings and edge distances for reduced anchorage depth

**Annex B2**

**Table B3: Minimum spacings and edge distances, standard anchorage depth, Option 1 Throughbolt**

Anchor size			M8	M10	M12	M16	M20	M24	M27
<b>Standard thickness of concrete member</b>									
<b>Steel zinc plated</b>									
Standard thickness of member	$h_{min,1}$	[mm]	100	120	140	170	200	230	250
<b>Cracked concrete</b>									
Minimum spacing	$s_{min}$	[mm]	40	45	60	60	95	100	125
	for $c \geq$	[mm]	70	70	100	100	150	180	300
Minimum edge distance	$c_{min}$	[mm]	40	45	60	60	95	100	180
	for $s \geq$	[mm]	80	90	140	180	200	220	540
<b>Non-cracked concrete</b>									
Minimum spacing	$s_{min}$	[mm]	40	45	60	65	90	100	125
	for $c \geq$	[mm]	80	70	120	120	180	180	300
Minimum edge distance	$c_{min}$	[mm]	50	50	75	80	130	100	180
	for $s \geq$	[mm]	100	100	150	150	240	220	540
<b>Stainless steel A4, HCR</b>									
Standard thickness of member	$h_{min,1}$	[mm]	100	120	140	160	200	250	
<b>Cracked concrete</b>									
Minimum spacing	$s_{min}$	[mm]	40	50	60	60	95	125	
	for $c \geq$	[mm]	70	75	100	100	150	125	
Minimum edge distance	$c_{min}$	[mm]	40	55	60	60	95	125	
	for $s \geq$	[mm]	80	90	140	180	200	125	
<b>Non-cracked concrete</b>									
Minimum spacing	$s_{min}$	[mm]	40	50	60	65	90	125	
	for $c \geq$	[mm]	80	75	120	120	180	125	
Minimum edge distance	$c_{min}$	[mm]	50	60	75	80	130	125	
	for $s \geq$	[mm]	100	120	150	150	240	125	
<b>Minimum thickness of concrete member</b>									
<b>Steel zinc plated and stainless steel A4, HCR</b>									
Minimum thickness of member	$h_{min,2}$	[mm]	80	100	120	140			
<b>Cracked concrete</b>									
Minimum spacing	$s_{min}$	[mm]	40	45	60	70			
	for $c \geq$	[mm]	70	90	100	160			
Minimum edge distance	$c_{min}$	[mm]	40	50	60	80			
	for $s \geq$	[mm]	80	115	140	180			
<b>Non-cracked concrete</b>									
Minimum spacing	$s_{min}$	[mm]	40	60	60	80			
	for $c \geq$	[mm]	80	140	120	180			
Minimum edge distance	$c_{min}$	[mm]	50	90	75	90			
	for $s \geq$	[mm]	100	140	150	200			
<b>Fire exposure from one side</b>									
Minimum spacing	$s_{min,fi}$	[mm]	See normal ambient temperature						
Minimum edge distance	$c_{min,fi}$	[mm]	See normal ambient temperature						
<b>Fire exposure from more than one side</b>									
Minimum spacing	$s_{min,fi}$	[mm]	See normal ambient temperature						
Minimum edge distance	$c_{min,fi}$	[mm]	$\geq 300$ mm						

Intermediate values by linear interpolation.

**JCP Option 1 Throughbolt**

**Intended use**  
Minimum spacings and edge distances for standard anchorage depth

**Annex B3**

### Installation instructions Option 1 Throughbolt

The fitness for use of the anchor can only be assumed if the anchor is installed as follows:

- Anchor installation carried out by appropriately qualified personnel and under the supervision of the person responsible for technical matters of the site,
- Use of the anchor only as supplied by the manufacturer without exchanging the components of the anchor.
- Checks before placing the anchor to ensure that the strength class of the concrete in which the anchor is to be placed is in the range given and is not lower than that of the concrete to which the characteristic loads apply
- Check of concrete being well compacted, e.g. without significant voids,
- Edge distances and spacing not less than the specified values without minus tolerances.

1		Drill hole perpendicular to concrete surface, positioning without damaging the reinforcement. In case of aborted hole: new drilling at a minimum distance away of twice the depth of the aborted hole or smaller distance if the aborted drill hole is filled with high strength mortar and if under shear or oblique tension load it is not in the direction of load application.
2		Blow out dust. Alternatively vacuum clean down to the bottom of the hole.
3		Check position of nut.
4		Drive in anchor, such that $h_{ef}$ or $h_{ef,red}$ depth is met. This compliance is ensured, if the thickness of fixture is not greater than the maximum thickness of fixture marked on the anchor in accordance with Annex A3.
5		Max. tightening torque $T_{inst}$ shall be applied by using calibrated torque wrench.

### JCP Option 1 Throughbolt

Intended Use  
Installation instructions

Annex B4

**Table B4: Installation parameters Option 1 Throughbolt ITS**

Anchor size			M6	M8	M10	M12
Effective anchorage depth	$h_{ef}$	[mm]	45	58	65	80
Drill hole diameter	$d_0$	[mm]	8	10	12	16
Cutting diameter of drill bit	$d_{cut} \leq$	[mm]	8,45	10,45	12,5	16,5
Depth of drill hole	$h_1 \geq$	[mm]	60	75	90	105
Screwing depth of threaded rod	$L_{sd}^{2)} \geq$	[mm]	9	12	15	18
Installation moment, zinc plated steel	S	[Nm]	10	30	30	55
	SK	[Nm]	10	25	40	50
	B	[Nm]	8	25	30	45
Installation moment, stainless steel A4, HCR	S	[Nm]	15	40	50	100
	SK	[Nm]	12	25	45	60
	B	[Nm]	8	25	40	80
<b>Installation type V (Pre-setting installation)</b>						
Diameter of clearance hole in the fixture	$d_f \leq$	[mm]	7	9	12	14
Minimum thickness of fixture	S	[mm]	1	1	1	1
	SK	[mm]	5	7	8	9
	B	[mm]	1	1	1	1
<b>Installation type D (Through-setting installation)</b>						
Diameter of clearance hole in the fixture	$d_f \leq$	[mm]	9	12	14	18
Minimum thickness of fixture <sup>1)</sup>	S	[mm]	5	7	8	9
	SK	[mm]	9	12	14	16
	B	[mm]	5	7	8	9

<sup>1)</sup> The minimum thickness of fixture can be reduced to the value of installation type V, if the shear load at steel failure is designed with lever arm.

<sup>2)</sup> see Annex A2

**Table B5: Minimum spacings and edge distances Option 1 Throughbolt ITS**

Anchor size			M6	M8	M10	M12
Minimum thickness of concrete member	$h_{min}$	[mm]	100	120	130	160
<b>Cracked concrete</b>						
Minimum spacing	$s_{min}$	[mm]	50	60	70	80
	for $c \geq$	[mm]	60	80	100	120
Minimum edge distance	$c_{min}$	[mm]	50	60	70	80
	for $s \geq$	[mm]	75	100	100	120
<b>Non-cracked concrete</b>						
Minimum spacing	$s_{min}$	[mm]	50	60	65	80
	for $c \geq$	[mm]	80	100	120	160
Minimum edge distance	$c_{min}$	[mm]	50	60	70	100
	for $s \geq$	[mm]	115	155	170	210
<b>Fire exposure from one side</b>						
Minimum spacing	$s_{min,fi}$	[mm]	See normal temperature			
Minimum edge distance	$c_{min,fi}$	[mm]	See normal temperature			
<b>Fire exposure from more than one side</b>						
Minimum spacing	$s_{min,fi}$	[mm]	See normal temperature			
Minimum edge distance	$c_{min,fi}$	[mm]	$\geq 300$ mm			

**JCP Option 1 Throughbolt ITS**

Intended use  
Installation parameters, minimum spacings and edge distances

**Annex B5**



## Installation instructions **Option 1 Throughbolt ITS**

The fitness for use of the anchor can only be assumed if the anchor is installed as follows:

- Anchor installation carried out by appropriately qualified personnel and under the supervision of the person responsible for technical matters of the site,
- Use of the anchor only as supplied by the manufacturer without exchanging the components of an anchor.
- Checks before placing the anchor to ensure that the strength class of the concrete in which the anchor is to be placed is in the range given and is not lower than that of the concrete to which the characteristic loads apply
- Check of concrete being well compacted, e.g. without significant voids,
- Edge distances and spacing not less than the specified values without minus tolerances.

### Pre-setting installation

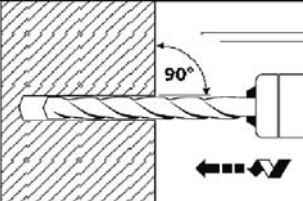
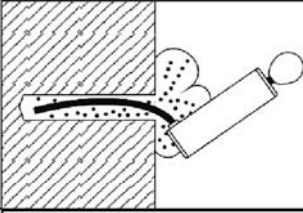
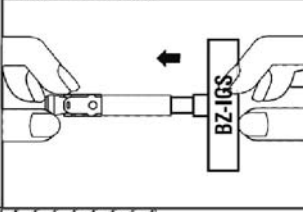
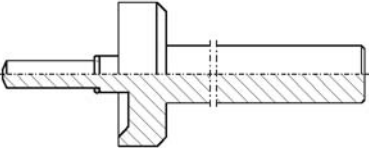
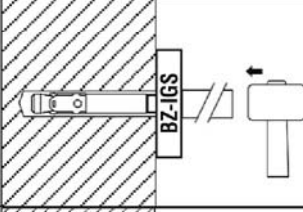
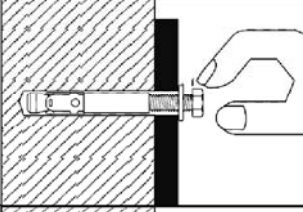
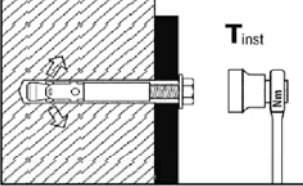
1		<p>Drill hole perpendicular to concrete surface, positioning without damaging the reinforcement.</p> <p>In case of aborted hole: new drilling at a minimum distance away twice the depth of the aborted hole or smaller distance if the aborted drill hole is filled with high strength mortar and if under shear or oblique tension load it is not in the direction of load application.</p>
2		<p>Blow out dust. Alternatively vacuum clean down to the bottom of the hole.</p>
3		<p>Setting tool for <b>pre-setting installation</b> insert in anchor.</p> 
4		<p>Drive in anchor with setting tool.</p>
5		<p>Drive in screw.</p>
6		<p>Max. tightening torque <math>T_{inst}</math> may be applied by using calibrated torque wrench.</p>

### JCP Option 1 Throughbolt ITS

**Intended Use**  
Installation instructions for pre-setting installation

**Annex B6**

## Installation instructions **Option 1 Throughbolt ITS**

### Through-setting installation

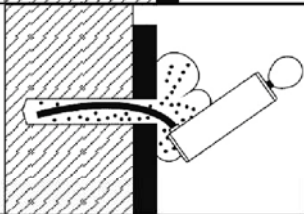
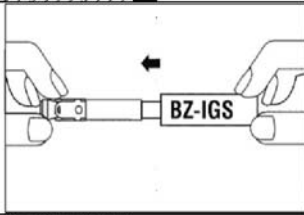
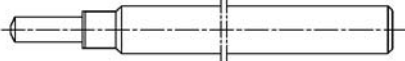
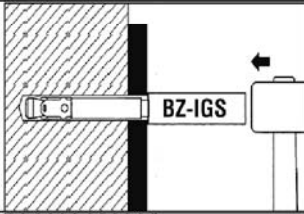
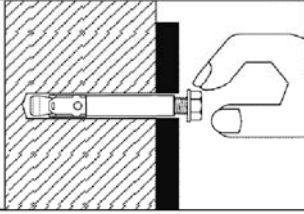
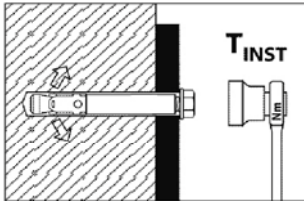



1		<p>Drill hole perpendicular to concrete surface, positioning without damaging the reinforcement.</p> <p>In case of aborted hole: new drilling at a minimum distance away of twice the depth of the aborted hole or smaller distance if the aborted drill hole is filled with high strength mortar and if under shear or oblique tension load it is not in the direction of load application.</p>
2		<p>Blow out dust. Alternatively vacuum clean down to the bottom of the hole.</p>
3		<p>Setting tool for <b>through-setting installation</b> insert in anchor.</p> 
4		<p>Drive in anchor with setting tool.</p>
5		<p>Drive in screw.</p>
6		<p>Max. tightening torque <math>T_{inst}</math> may be applied by using calibrated torque wrench.</p>

### JCP Option 1 Throughbolt ITS

**Intended Use**  
Installation instructions for through-setting installation

**Annex B7**

**Table C1:** Characteristic values for **tension loads**, Option 1 Throughbolt **zinc plated**, **cracked concrete**, static and quasi-static action, design method A according to ETAG 001, Annex C or CEN/TS 1992-4

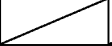
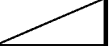
Anchor size			M8	M10	M12	M16	M20	M24	M27
Installation safety factor	$\gamma_2 = \gamma_{inst}$	[-]	1,0						
<b>Steel failure</b>									
Characteristic tension resistance	$N_{Rk,s}$	[kN]	16	27	40	60	86	126	196
Partial safety factor	$\gamma_{Ms}$	[-]	1,53		1,5		1,6	1,5	
<b>Pull-out</b>									
<b>Standard anchorage depth</b>									
Characteristic resistance in concrete C20/25	$N_{Rk,p}$	[kN]	5	9	16	25	1)	1)	1)
<b>Reduced anchorage depth</b>									
Characteristic resistance in concrete C20/25	$N_{Rk,p,red}$	[kN]	5	7,5	1)	1)			
Increasing factor for $N_{Rk,p}$ and $N_{Rk,p,red}$	$\psi_c$	[-]	$\left(\frac{f_{ck,cube}}{25}\right)^{0,5}$						
<b>Concrete cone failure</b>									
Effective anchorage depth	$h_{ef}$	[mm]	46	60	70	85	100	115	125
Reduced anchorage depth	$h_{ef,red}$	[mm]	35 <sup>2)</sup>	40	50	65			
Factor according to CEN/TS 1992-4	$k_{cr}$	[-]	7,2						

<sup>1)</sup> Pull-out is not decisive.

<sup>2)</sup> Use restricted to anchoring of structural components statically indeterminate.

**JCP Option 1 Throughbolt**

**Performance**

Characteristic values for **tension loads**, Option 1 Throughbolt **zinc plated** **cracked concrete**, static and quasi-static action, design method A according to ETAG 001, Annex C or CEN/TS 1992-4

**Annex C1**

**Table C2:** Characteristic values for **tension loads**, Option 1 Throughbolt **A4 / HCR**, **cracked concrete**, static and quasi-static action, design method A according to ETAG 001, Annex C or CEN/TS 1992-4

Anchor size			M8	M10	M12	M16	M20	M24
Installation safety factor	$\gamma_2 = \gamma_{inst}$	[-]	1,0					
<b>Steel failure</b>								
Characteristic tension resistance	$N_{Rk,s}$	[kN]	16	27	40	64	108	110
Partial safety factor	$\gamma_{Ms}$	[-]	1,5				1,68	1,5
<b>Pull-out</b>								
<b>Standard anchorage depth</b>								
Characteristic resistance in concrete C20/25	$N_{Rk,p}$	[kN]	5	9	16	25	1)	40
<b>Reduced anchorage depth</b>								
Characteristic resistance in concrete C20/25	$N_{Rk,p,red}$	[kN]	5	7,5	1)	1)		
Increasing factor for $N_{Rk,p}$ and $N_{Rk,p,red}$	$\psi_c$	[-]	$\left(\frac{f_{ck,cube}}{25}\right)^{0,5}$					
<b>Concrete cone failure</b>								
Effective anchorage depth	$h_{ef}$	[mm]	46	60	70	85	100	125
Reduced anchorage depth	$h_{ef,red}$	[mm]	35 <sup>2)</sup>	40	50	65		
Factor according to CEN/TS 1992-4	$k_{cr}$	[-]	7,2					

<sup>1)</sup> Pull-out is not decisive.

<sup>2)</sup> Use restricted to anchoring of structural components statically indeterminate.

**JCP Option 1 Throughbolt**

**Performance**

Characteristic values for **tension loads**, Option 1 Throughbolt **A4 / HCR**, **cracked concrete**, static and quasi-static action, design method A according to ETAG 001, Annex C or CEN/TS 1992-4

**Annex C2**

**Table C3:** Characteristic values for **tension loads**, Option 1 Throughbolt **zinc plated, non-cracked concrete**, static and quasi-static action, design method A according to ETAG 001, Annex C or CEN/TS 1992-4

Anchor size		M8	M10	M12	M16	M20	M24	M27
Installation safety factor	$\gamma_2 = \gamma_{inst}$ [-]	1,0						
<b>Steel failure</b>								
Characteristic tension resistance	$N_{Rk,s}$ [kN]	16	27	40	60	86	126	196
Partial safety factor	$\gamma_{Ms}$ [-]	1,53		1,5		1,6	1,5	
<b>Pull-out</b>								
<b>Standard anchorage depth</b>								
Characteristic resistance in non-cracked concrete C20/25	$N_{Rk,p}$ [kN]	12	16	25	35	1)	1)	1)
<b>Reduced anchorage depth</b>								
Characteristic resistance in non-cracked concrete C20/25	$N_{Rk,p,red}$ [kN]	7,5	9	1)	1)			
<b>Splitting</b> For the proof against splitting failure $N_{Rk,c}^0$ has to be replaced by $N_{Rk,sp}^0$ with consideration of the member thickness								
<b>Standard anchorage depth</b>								
Splitting for <b>standard thickness of concrete member</b> (The higher resistance of case 1 and case 2 may be applied; the values $s_{cr,sp}$ and $c_{cr,sp}$ may be linearly interpolated for the member thickness $h_{min} < h < h_{std}$ (Case 2); $\psi_{h,sp} = 1,0$ )								
Standard thickness of concrete	$h_{min,1} \geq$ [mm]	100	120	140	170	200	230	250
<b>Case 1</b>								
Characteristic resistance in non-cracked concrete C20/25	$N_{Rk,sp}^0$ [kN]	9	12	20	30	40	1)	50
Spacing (edge distance)	$s_{cr,sp} (= 2 c_{cr,sp})$ [mm]	3 $h_{ef}$						
<b>Case 2</b>								
Characteristic resistance in non-cracked concrete C20/25	$N_{Rk,sp}^0$ [kN]	12	16	25	35	1)	1)	1)
Spacing (edge distance)	$s_{cr,sp} (= 2 c_{cr,sp})$ [mm]	4 $h_{ef}$				4,4 $h_{ef}$	3 $h_{ef}$	5 $h_{ef}$
<b>Splitting for minimum thickness of concrete member</b>								
Minimum thickness of concrete	$h_{min,2} \geq$ [mm]	80	100	120	140			
Characteristic resistance in non-cracked concrete C20/25	$N_{Rk,sp}^0$ [kN]	12	16	25	35			
Spacing (edge distance)	$s_{cr,sp} (= 2 c_{cr,sp})$ [mm]	5 $h_{ef}$						
<b>Reduced anchorage depth</b>								
Minimum thickness of concrete	$h_{min,3} \geq$ [mm]	80	80	100	140			
Characteristic resistance in non-cracked concrete C20/25	$N_{Rk,sp}^0$ [kN]	7,5	9	1)	1)			
Spacing (edge distance)	$s_{cr,sp} (= 2 c_{cr,sp})$ [mm]	200	200	250	300			
Increasing factor for $N_{Rk,p(red)}$ and $N_{Rk,sp}^0$	$\psi_c$ [-]	$\left(\frac{f_{ck,cube}}{25}\right)^{0,5}$						
<b>Concrete cone failure</b>								
Effective anchorage depth	$h_{ef}$ [mm]	46	60	70	85	100	115	125
Reduced anchorage depth	$h_{ef,red}$ [mm]	35 <sup>2)</sup>	40	50	65			
Factor according to CEN/TS 1992-4	$k_{ucr}$ [-]	10,1						

1) Pull-out is not decisive.

2) Use restricted to anchoring of structural components statically indeterminate.

**JCP Option 1 Throughbolt**

**Performance**

Characteristic values for **tension loads**, Option 1 Throughbolt **zinc plated, non-cracked concrete**, static and quasi-static action, design method A according to ETAG 001, Annex C or CEN/TS 1992-4

**Annex C3**

**Table C4:** Characteristic values for **tension loads**, Option 1 Throughbolt **A4 / HCR**, **non-cracked concrete**, static and quasi-static action, design method A according to ETAG 001, Annex C or CEN/TS 1992-4

Anchor size			M8	M10	M12	M16	M20	M24
Installation safety factor	$\gamma_2 = \gamma_{inst}$	[-]	1,0					
<b>Steel failure</b>								
Characteristic tension resistance	$N_{Rk,s}$	[kN]	16	27	40	64	108	110
Partial safety factor	$\gamma_{Ms}$	[-]	1,5				1,68	1,5
<b>Pull-out</b>								
<b>Standard anchorage depth</b>								
Characteristic resistance in non-cracked concrete C20/25	$N_{Rk,p}$	[kN]	12	16	25	35	1)	1)
<b>Reduced anchorage depth</b>								
Characteristic resistance in non-cracked concrete C20/25	$N_{Rk,p,red}$	[kN]	7,5	9	1)	1)		
<b>Splitting</b> For the proof against splitting failure $N_{Rk,c}^0$ has to be replaced by $N_{Rk,sp}^0$ with consideration of the member thickness								
<b>Standard anchorage depth</b>								
Splitting for <b>standard thickness of concrete member</b> (The higher resistance of case 1 and case 2 may be applied; the values $s_{cr,sp}$ and $c_{cr,sp}$ may be linearly interpolated for the member thickness $h_{min} < h < h_{std}$ (Case 2); $\psi_{h,sp} = 1,0$ )								
Standard thickness of concrete	$h_{min,1} \geq$	[mm]	100	120	140	160	200	250
<b>Case 1</b>								
Characteristic resistance in non-cracked concrete C20/25	$N_{Rk,sp}^0$	[kN]	9	12	20	30	40	
Spacing (edge distance)	$s_{cr,sp} (= 2 c_{cr,sp})$	[mm]	3 $h_{ef}$					
<b>Case 2</b>								
Characteristic resistance in non-cracked concrete C20/25	$N_{Rk,sp}^0$	[kN]	12	16	25	35	1)	1)
Spacing (edge distance)	$s_{cr,sp} (= 2 c_{cr,sp})$	[mm]	230	250	280	400	440	500
<b>Splitting for minimum thickness of concrete member</b>								
Minimum thickness of concrete	$h_{min,2} \geq$	[mm]	80	100	120	140		
Characteristic resistance in non-cracked concrete C20/25	$N_{Rk,sp}^0$	[kN]	12	16	25	35		
Spacing (edge distance)	$s_{cr,sp} (= 2 c_{cr,sp})$	[mm]	5 $h_{ef}$					
<b>Reduced anchorage depth</b>								
Minimum thickness of concrete	$h_{min,3} \geq$	[mm]	80	80	100	140		
Characteristic resistance in non-cracked concrete C20/25	$N_{Rk,sp}^0$	[kN]	7,5	9	1)	1)		
Spacing (edge distance)	$s_{cr,sp} (= 2 c_{cr,sp})$	[mm]	200	200	250	300		
Increasing factor for $N_{Rk,p(red)}$ and $N_{Rk,sp}^0$	$\psi_c$	[-]	$\left(\frac{f_{ck,cube}}{25}\right)^{0,5}$					
<b>Concrete cone failure</b>								
Effective anchorage depth	$h_{ef}$	[mm]	46	60	70	85	100	125
Reduced anchorage depth	$h_{ef,red}$	[mm]	35 <sup>2)</sup>	40	50	65		
Factor according to CEN/TS 1992-4	$k_{ucr}$	[-]	10,1					

<sup>1)</sup> Pull-out is not decisive.

<sup>2)</sup> Use restricted to anchoring of structural components statically indeterminate.

**JCP Option 1 Throughbolt**

**Performance**

Characteristic values for **tension loads**, Option 1 Throughbolt **A4 / HCR**, **non-cracked concrete**, static and quasi-static action, design method A according to ETAG 001, Annex C or CEN/TS 1992-4

**Annex C4**

**Table C5:** Characteristic values for **shear loads**, Option 1 Throughbolt, **cracked** and **non-cracked concrete**, static or quasi static action, design method A according to ETAG 001, Annex C or CEN/TS 1992-4

Anchor size			M8	M10	M12	M16	M20	M24	M27	
Installation safety factor	$\gamma_2 = \gamma_{inst}$	[-]	1,0							
<b>Steel failure without lever arm, Steel zinc plated</b>										
Characteristic shear resistance	$V_{Rk,s}$	[kN]	12,2	20,1	30	55	69	114	169,4	
Factor for ductility	$k_2$	[-]	1,0							
Partial safety factor	$\gamma_{Ms}$	[-]	1,25			1,33		1,25	1,25	
<b>Steel failure without lever arm, Stainless steel A4, HCR</b>										
Characteristic shear resistance	$V_{Rk,s}$	[kN]	13	20	30	55	86	123,6	/	
Factor for ductility	$k_2$	[-]	1,0							
Partial safety factor	$\gamma_{Ms}$	[-]	1,25			1,4		1,25		
<b>Steel failure with lever arm, Steel zinc plated</b>										
Characteristic bending resistance	$M^0_{Rk,s}$	[Nm]	23	47	82	216	363	898	1331,5	
Partial safety factor	$\gamma_{Ms}$	[-]	1,25			1,33		1,25	1,25	
<b>Steel failure with lever arm, Stainless steel A4, HCR</b>										
Characteristic bending resistance	$M^0_{Rk,s}$	[Nm]	26	52	92	200	454	785,4	/	
Partial safety factor	$\gamma_{Ms}$	[-]	1,25			1,4		1,25		
<b>Concrete pry-out failure</b>										
Factor k acc. ETAG 001, Annex C or $k_3$ acc. CEN/TS 1992-4	$k_{(3)}$	[-]	2,4			2,8				
<b>Concrete edge failure</b>										
Effective length of anchor in shear loading with $h_{ef}$	Steel zinc plated	$l_f$	[mm]	46	60	70	85	100	115	125
	Stainless steel A4, HCR	$l_f$	[mm]	46	60	70	85	100	125	/
Effective length of anchor in shear loading with $h_{ef,red}$	Steel zinc plated	$l_{f,red}$	[mm]	35	40	50	65	/	/	
	Stainless steel A4, HCR	$l_{f,red}$	[mm]	35	40	50	65			
Outside diameter of anchor	$d_{nom}$	[mm]	8	10	12	16	20	24	27	

**JCP Option 1 Throughbolt**

**Performance**

Characteristic values for **shear loads**, Option 1 Throughbolt, **cracked** and **non-cracked concrete**, static or quasi static action, design method A according to ETAG 001, Annex C or CEN/TS 1992-4

**Annex C5**

**Table C6:** Characteristic resistance for **seismic loading**, Option 1 Throughbolt, **standard anchorage depth**, performance category **C1** and **C2**, design according to TR045

Tension loads							
Anchor size			M10	M12	M16	M20	
Installation safety factor		$\gamma_2 = \gamma_{inst}$	[-]	1,0			
Steel failure, steel zinc plated							
Characteristic resistance <b>C1</b>		$N_{Rk,s,seis,C1}$	[kN]	27	40	60	86
Characteristic resistance <b>C2</b>		$N_{Rk,s,seis,C2}$	[kN]	27	40	60	86
Partial safety factor		$\gamma_{Ms,seis}$	[-]	1,53	1,5		1,6
Steel failure, stainless steel A4, HCR							
Characteristic resistance <b>C1</b>		$N_{Rk,s,seis,C1}$	[kN]	27	40	64	108
Characteristic resistance <b>C2</b>		$N_{Rk,s,seis,C2}$	[kN]	27	40	64	108
Partial safety factor		$\gamma_{Ms,seis}$	[-]	1,5		1,68	
Pull-out							
Characteristic resistance <b>C1</b>		$N_{Rk,p,seis,C1}$	[kN]	9	16	25	36
Characteristic resistance <b>C2</b>		$N_{Rk,p,seis,C2}$	[kN]	3,6	10,2	13,8	22,4
Shear loads							
Steel failure without lever arm, Steel zinc plated							
Characteristic resistance <b>C1</b>		$V_{Rk,s,seis,C1}$	[kN]	20	27	44	69
Characteristic resistance <b>C2</b>		$V_{Rk,s,seis,C2}$	[kN]	14	16,2	35,7	55,2
Partial safety factor		$\gamma_{Ms,seis}$	[-]	1,25			1,33
Steel failure without lever arm, Stainless steel A4, HCR							
Characteristic resistance <b>C1</b>		$V_{Rk,s,seis,C1}$	[kN]	20	27	44	69
Characteristic resistance <b>C2</b>		$V_{Rk,s,seis,C2}$	[kN]	14	16,2	35,7	55,2
Partial safety factor		$\gamma_{Ms,seis}$	[-]	1,25			1,4

JCP Option 1 Throughbolt

Performance

Characteristic resistance for **seismic loading**, Option 1 Throughbolt, **standard anchorage depth**, performance category **C1** and **C2**, design according to TR045

Annex C6



**Table C7: Characteristic values for tension and shear load under fire exposure, Option 1**  
Throughbolt, **standard anchorage depth**, cracked and non-cracked concrete  
C20/25 to C50/60, design acc. to TR 020 or CEN/TS 1992-4, Annex D

Anchor size		M8	M10	M12	M16	M20	M24	M27		
<b>Tension load</b>										
<b>Steel failure</b>										
<b>Steel zinc plated</b>										
Characteristic resistance	R30	$N_{Rk,s,fi}$	[kN]	1,4	2,2	3,2	6,0	9,4	13,6	17,6
	R60			1,1	1,8	2,8	5,2	8,2	11,8	15,3
	R90			0,8	1,4	2,4	4,4	6,9	10,0	13,0
	R120			0,7	1,2	2,2	4,0	6,3	9,1	11,8
<b>Stainless steel A4, HCR</b>										
Characteristic resistance	R30	$N_{Rk,s,fi}$	[kN]	3,8	6,9	11,5	21,5	33,5	48,2	/
	R60			2,9	5,2	8,6	16	25,0	35,9	
	R90			2,0	3,5	5,6	10,5	16,4	23,6	
	R120			1,6	2,7	4,2	7,8	12,1	17,4	
<b>Shear load</b>										
<b>Steel failure without lever arm</b>										
<b>Steel zinc plated</b>										
Characteristic resistance	R30	$V_{Rk,s,fi}$	[kN]	1,6	2,6	3,8	7,0	11	16	20,6
	R60			1,5	2,5	3,6	6,8	11	15	19,8
	R90			1,2	2,1	3,5	6,5	10	15	19,0
	R120			1,0	2,0	3,4	6,4	10	14	18,6
<b>Stainless steel A4, HCR</b>										
Characteristic resistance	R30	$V_{Rk,s,fi}$	[kN]	3,8	6,9	11,5	21,5	33,5	48,2	/
	R60			2,9	5,2	8,6	16	25,0	35,9	
	R90			2,0	3,5	5,6	10,5	16,4	23,6	
	R120			1,6	2,7	4,2	7,8	12,1	17,4	
<b>Steel failure with lever arm</b>										
<b>Steel zinc plated</b>										
Characteristic resistance	R30	$M^0_{Rk,s,fi}$	[Nm]	1,7	3,3	5,9	15	29	50	75
	R60			1,6	3,2	5,6	14	28	48	72
	R90			1,2	2,7	5,4	14	27	47	69
	R120			1,1	2,5	5,3	13	26	46	68
<b>Stainless steel A4, HCR</b>										
Characteristic resistance	R30	$M^0_{Rk,s,fi}$	[Nm]	3,8	9,0	17,9	45,5	88,8	153,5	/
	R60			2,9	6,8	13,3	33,9	66,1	114,3	
	R90			2,1	4,5	8,8	22,2	43,4	75,1	
	R120			1,6	3,4	6,5	16,4	32,1	55,5	

The characteristic resistance for pull-out failure, concrete cone failure, concrete pry-out and concrete edge failure can be calculated according to TR020 / CEN/TS 1992-4. If pull-out is not decisive  $N_{Rk,p}$  in Eq. 2.4 and Eq. 2.5, TR 020 must be replaced by  $N^0_{Rk,c}$ .

**JCP Option 1 Throughbolt**

**Performance**

Characteristic values for tension and shear load under fire exposure, Option 1  
Throughbolt, **standard anchorage depth**, cracked and non-cracked concrete C20/25 to  
C50/60, design acc. to TR 020 or CEN/TS 1992-4, Annex D

**Annex C7**

**Table C8: Displacements under tension load, Option 1 Throughbolt**

Anchor size			M8	M10	M12	M16	M20	M24	M27
<b>Standard anchorage depth</b>									
<b>Steel zinc plated</b>									
Tension load in cracked concrete	N	[kN]	2,4	4,3	7,6	11,9	17,1	21,1	24
Displacement	$\delta_{N0}$	[mm]	0,6	1,0	0,4	1,0	0,9	0,7	0,9
	$\delta_{N\infty}$	[mm]	1,4	1,2	1,4	1,3	1,0	1,2	1,4
Tension load in non-cracked concrete	N	[kN]	5,7	7,6	11,9	16,7	23,8	29,6	34
Displacement	$\delta_{N0}$	[mm]	0,4	0,5	0,7	0,3	0,4	0,5	0,3
	$\delta_{N\infty}$	[mm]	0,8		1,4	0,8		1,4	
<b>Displacements under seismic tension loads C2</b>									
Displacements for DLS	$\delta_{N,seis,C2(DLS)}$	[mm]	/	4,1	4,9	3,6	5,1	/	/
Displacements for ULS	$\delta_{N,seis,C2(ULS)}$	[mm]	/	13,8	15,7	9,5	15,2	/	/
<b>Stainless steel A4, HCR</b>									
Tension load in cracked concrete	N	[kN]	2,4	4,3	7,6	11,9	17,1	19,0	/
Displacement	$\delta_{N0}$	[mm]	0,7	1,8	0,4	0,7	0,9	0,5	/
	$\delta_{N\infty}$	[mm]	1,2	1,4	1,4	1,4	1,0	1,8	/
Tension load in non-cracked concrete	N	[kN]	5,8	7,6	11,9	16,7	23,8	33,5	/
Displacement	$\delta_{N0}$	[mm]	0,6	0,5	0,7	0,2	0,4	0,5	/
	$\delta_{N\infty}$	[mm]	1,2	1,0	1,4	0,4	0,8	1,1	/
<b>Displacements under seismic tension loads C2</b>									
Displacements for DLS	$\delta_{N,seis,C2(DLS)}$	[mm]	/	4,1	4,9	3,6	5,1	/	/
Displacements for ULS	$\delta_{N,seis,C2(ULS)}$	[mm]	/	13,8	15,7	9,5	15,2	/	/
<b>Reduced anchorage depth</b>									
Tension load in cracked concrete	N	[kN]	2,4	3,6	6,1	9,0	/	/	/
Displacement	$\delta_{N0}$	[mm]	0,8	0,7	0,5	1,0	/	/	/
	$\delta_{N\infty}$	[mm]	1,2	1,0	0,8	1,1	/	/	/
Tension load in non-cracked concrete	N	[kN]	3,7	4,3	8,5	12,6	/	/	/
Displacement	$\delta_{N0}$	[mm]	0,1	0,2	0,2	0,2	/	/	/
	$\delta_{N\infty}$	[mm]	0,7	0,7	0,7	0,7	/	/	/

**JCP Option 1 Throughbolt**

**Performance**  
Displacements under tension load

**Annex C8**

**Table C9: Displacements under shear load, Option 1 Throughbolt**

Anchor size			M8	M10	M12	M16	M20	M24	M27
<b>Standard anchorage depth</b>									
<b>Steel zinc plated</b>									
Shear load in cracked and non-cracked concrete	V	[kN]	6,9	11,4	17,1	31,4	36,8	64,9	96,8
Displacement	$\delta_{V0}$	[mm]	2,0	3,2	3,6	3,5	1,8	3,5	3,6
	$\delta_{V\infty}$	[mm]	3,0	4,7	5,5	5,3	2,7	5,3	5,4
<b>Displacements under seismic shear loads C2</b>									
Displacements for DLS	$\delta_{V,seis,C2(DLS)}$	[mm]	/	2,7	3,5	4,3	4,7	/	/
Displacements for ULS	$\delta_{V,seis,C2(ULS)}$	[mm]	/	5,3	9,5	9,6	10,1	/	/
<b>Stainless steel A4, HCR</b>									
Shear load in cracked and non-cracked concrete	V	[kN]	7,3	11,4	17,1	31,4	43,8	70,6	/
Displacement	$\delta_{V0}$	[mm]	1,9	2,4	4,0	4,3	2,9	2,8	/
	$\delta_{V\infty}$	[mm]	2,9	3,6	5,9	6,4	4,3	4,2	/
<b>Displacements under seismic shear loads C2</b>									
Displacements for DLS	$\delta_{V,seis,C2(DLS)}$	[mm]	/	2,7	3,5	4,3	4,7	/	/
Displacements for ULS	$\delta_{V,seis,C2(ULS)}$	[mm]	/	5,3	9,5	9,6	10,1	/	/
<b>Reduced anchorage depth</b>									
<b>Steel zinc plated</b>									
Shear load in cracked and non-cracked concrete	V	[kN]	6,9	11,4	17,1	31,4	/	/	/
Displacement	$\delta_{V0}$	[mm]	2,0	3,2	3,6	3,5	/	/	/
	$\delta_{V\infty}$	[mm]	3,0	4,7	5,5	5,3	/	/	/
<b>Stainless steel A4, HCR</b>									
Shear load in cracked and non-cracked concrete	V	[kN]	7,3	11,4	17,1	31,4	/	/	/
Displacement	$\delta_{V0}$	[mm]	1,9	2,4	4,0	4,3	/	/	/
	$\delta_{V\infty}$	[mm]	2,9	3,6	5,9	6,4	/	/	/

**JCP Option 1 Throughbolt**

**Performance**  
Displacements under shear load

**Annex C9**

**Table C10:** Characteristic values for **tension loads, Option 1 Throughbolt ITS, cracked concrete**, static and quasi-static action, design method A according to ETAG 001, Annex C or CEN/TS 1992-4

Anchor size			M6	M8	M10	M12
Installation safety factor	$\gamma_2 = \gamma_{inst}$	[-]	1,2			
<b>Steel failure</b>						
Characteristic tension resistance, steel zinc plated	$N_{Rk,s}$	[kN]	16,1	22,6	26,0	56,6
Partial safety factor	$\gamma_{Ms}$	[-]	1,5			
Characteristic tension resistance, stainless steel A4, HCR	$N_{Rk,s}$	[kN]	14,1	25,6	35,8	59,0
Partial safety factor	$\gamma_{Ms}$	[-]	1,87			
<b>Pull-out failure</b>						
Characteristic resistance in cracked concrete C20/25	$N_{Rk,p}$	[kN]	5	9	12	20
Increasing factor	$\psi_c$	[-]	$\left(\frac{f_{ck,cube}}{25}\right)^{0,5}$			
<b>Concrete cone failure</b>						
Effective anchorage depth	$h_{ef}$	[mm]	45	58	65	80
Factor according to CEN/TS 1992-4	$k_{cr}$	[-]	7,2			

**JCP Option 1 Throughbolt ITS**

**Performance**

Characteristic values for **tension loads, Option 1 Throughbolt ITS, cracked concrete**, static and quasi-static action, design method A according to ETAG 001, Annex C or CEN/TS 1992-4

**Annex C10**

**Table C11:** Characteristic values for **tension loads, Option 1 Throughbolt ITS, non-cracked concrete**, static and quasi-static action, design method A according to ETAG 001, Annex C or CEN/TS 1992-4

Anchor size			M6	M8	M10	M12
Installation safety factor	$\gamma_2 = \gamma_{inst}$	[-]	1,2			
<b>Steel failure</b>						
Characteristic tension resistance, steel zinc plated	$N_{Rk,s}$	[kN]	16,1	22,6	26,0	56,6
Partial safety factor	$\gamma_{Ms}$	[-]	1,5			
Characteristic tension resistance, stainless steel A4, HCR	$N_{Rk,s}$	[kN]	14,1	25,6	35,8	59,0
Partial safety factor	$\gamma_{Ms}$	[-]	1,87			
<b>Pull-out</b>						
Characteristic resistance in non-cracked concrete C20/25	$N_{Rk,p}$	[kN]	12	16	20	30
<b>Splitting</b> ( $N_{Rk,c}^0$ has to be replaced by $N_{Rk,sp}^0$ . The higher resistance of Case 1 and Case 2 may be applied.)						
Minimum thickness of concrete member	$h_{min}$	[mm]	100	120	130	160
<b>Case 1</b>						
Characteristic resistance in non-cracked concrete C20/25	$N_{Rk,sp}^0$	[kN]	9	12	16	25
Spacing (edge distance)	$s_{cr,sp} (= 2 c_{cr,sp})$	[mm]	$3 h_{ef}$			
<b>Case 2</b>						
Characteristic resistance in non-cracked concrete C20/25	$N_{Rk,sp}^0$	[kN]	12	16	20	30
Spacing (edge distance)	$s_{cr,sp} (= 2 c_{cr,sp})$	[mm]	$5 h_{ef}$			
Increasing factor for $N_{Rk,p}$ and $N_{Rk,sp}^0$	$\psi_c$	[-]	$\left(\frac{f_{ck,cube}}{25}\right)^{0,5}$			
<b>Concrete cone failure</b>						
Effective anchorage depth	$h_{ef}$	[mm]	45	58	65	80
Factor according to CEN/TS 1992-4	$k_{ucr}$	[-]	10,1			

**JCP Option 1 Throughbolt ITS**

**Performance**

Characteristic values for **tension loads, Option 1 Throughbolt ITS, non-cracked concrete**, static and quasi-static action, design method A according to ETAG 001, Annex C or CEN/TS 1992-4

**Annex C11**

**Table C12: Characteristic values for shear loads, Option 1 Throughbolt ITS, cracked and non-cracked concrete, static and quasi-static action, design method A according to ETAG 001, Annex C or CEN/TS 1992-4**

Anchor size			M6	M8	M10	M12
Installation safety factor	$\gamma_2 = \gamma_{inst}$	[-]	1,0			
<b>Option 1 Throughbolt ITS, steel zinc plated</b>						
<b>Steel failure without lever arm, Installation type V</b>						
Characteristic shear resistance	$V_{Rk,s}$	[kN]	5,8	6,9	10,4	25,8
<b>Steel failure without lever arm, Installation type D</b>						
Characteristic shear resistance	$V_{Rk,s}$	[kN]	5,1	7,6	10,8	24,3
<b>Steel failure with lever arm, Installation type V</b>						
Characteristic bending resistance	$M^0_{Rk,s}$	[Nm]	12,2	30,0	59,8	104,6
<b>Steel failure with lever arm, Installation type D</b>						
Characteristic bending resistance	$M^0_{Rk,s}$	[Nm]	36,0	53,2	76,0	207
Partial safety factor for $V_{Rk,s}$ and $M^0_{Rk,s}$	$\gamma_{Ms}$	[-]	1,25			
Factor of ductility	$k_2$	[-]	1,0			
<b>Option 1 Throughbolt ITS, stainless steel A4, HCR</b>						
<b>Steel failure without lever arm, Installation type V</b>						
Characteristic shear resistance	$V_{Rk,s}$	[kN]	5,7	9,2	10,6	23,6
Partial safety factor	$\gamma_{Ms}$	[-]	1,25			
<b>Steel failure without lever arm, Installation type D</b>						
Characteristic shear resistance	$V_{Rk,s}$	[kN]	7,3	7,6	9,7	29,6
Partial safety factor	$\gamma_{Ms}$	[-]	1,25			
<b>Steel failure with lever arm, Installation type V</b>						
Characteristic bending resistance	$M^0_{Rk,s}$	[Nm]	10,7	26,2	52,3	91,6
Partial safety factor	$\gamma_{Ms}$	[-]	1,56			
<b>Steel failure with lever arm, Installation type D</b>						
Characteristic bending resistance	$M^0_{Rk,s}$	[Nm]	28,2	44,3	69,9	191,2
Partial safety factor	$\gamma_{Ms}$	[-]	1,25			
Factor of ductility	$k_2$	[-]	1,0			
<b>Concrete pry-out failure</b>						
Factor k acc. ETAG 001, Annex C or $k_3$ acc. CEN/TS 1992-4	$k_{(3)}$	[-]	1,5	1,5	2,0	2,0
<b>Concrete edge failure</b>						
Effective length of anchor in shear loading	$l_f$	[mm]	45	58	65	80
Effective diameter of anchor	$d_{nom}$	[mm]	8	10	12	16

**JCP Option 1 Throughbolt ITS**

**Performance**

Characteristic values for shear loads, **Option 1 Throughbolt ITS, cracked and non-cracked concrete**, static and quasi-static action, design method A according to ETAG 001, Annex C or CEN/TS 1992-4

**Annex C12**

**Table C13: Characteristic values for tension and shear load under fire exposure, Option 1 Throughbolt ITS, cracked and non-cracked concrete C20/25 to C50/60, design acc. to TR 020 or CEN/TS 1992-4, Annex D**

Anchor size		M6	M8	M10	M12		
<b>Tension load</b>							
<b>Steel failure</b>							
<b>Steel zinc plated</b>							
Characteristic resistance	R30	$N_{Rk,s,fi}$	[kN]	0,7	1,4	2,5	3,7
	R60			0,6	1,2	2,0	2,9
	R90			0,5	0,9	1,5	2,2
	R120			0,4	0,8	1,3	1,8
<b>Stainless steel A4, HCR</b>							
Characteristic resistance	R30	$N_{Rk,s,fi}$	[kN]	2,9	5,4	8,7	12,6
	R60			1,9	3,8	6,3	9,2
	R90			1,0	2,1	3,9	5,7
	R120			0,5	1,3	2,7	4,0
<b>Shear load</b>							
<b>Steel failure without lever arm</b>							
<b>Steel zinc plated</b>							
Characteristic resistance	R30	$V_{Rk,s,fi}$	[kN]	0,7	1,4	2,5	3,7
	R60			0,6	1,2	2,0	2,9
	R90			0,5	0,9	1,5	2,2
	R120			0,4	0,8	1,3	1,8
<b>Stainless steel A4, HCR</b>							
Characteristic resistance	R30	$V_{Rk,s,fi}$	[kN]	2,9	5,4	8,7	12,6
	R60			1,9	3,8	6,3	9,2
	R90			1,0	2,1	3,9	5,7
	R120			0,5	1,3	2,7	4,0
<b>Steel failure with lever arm</b>							
<b>Steel zinc plated</b>							
Characteristic resistance	R30	$M^0_{Rk,s,fi}$	[Nm]	0,5	1,4	3,3	5,7
	R60			0,4	1,2	2,6	4,6
	R90			0,4	0,9	2,0	3,4
	R120			0,3	0,8	1,6	2,8
<b>Stainless steel A4, HCR</b>							
Characteristic resistance	R30	$M^0_{Rk,s,fi}$	[Nm]	2,2	5,5	11,2	19,6
	R60			1,5	3,9	8,1	14,3
	R90			0,7	2,2	5,1	8,9
	R120			0,4	1,3	3,5	6,2

The characteristic resistance for pull-out failure, concrete cone failure, concrete pry-out failure and concrete edge failure can be designed according to TR020 / CEN/TS 1992-4.

**JCP Option 1 Throughbolt ITS**

**Performance**

Characteristic values for tension and shear loads under fire exposure, Option 1 Throughbolt ITS, cracked and non-cracked concrete C20/25 to C50/60, design acc. to TR 020 or CEN/TS 1992-4, Annex D

**Annex C13**

**Table C14: Displacements under tension load, Option 1 Throughbolt ITS**

Anchor size		M6	M8	M10	M12
Tension load in cracked concrete	N [kN]	2,0	3,6	4,8	8,0
Displacements	$\delta_{N0}$ [mm]	0,6	0,6	0,8	1,0
	$\delta_{N\infty}$ [mm]	0,8	0,8	1,2	1,4
Tension load in non-cracked concrete	N [kN]	4,8	6,4	8,0	12,0
Displacements	$\delta_{N0}$ [mm]	0,4	0,5	0,7	0,8
	$\delta_{N\infty}$ [mm]	0,8	0,8	1,2	1,4

**Table C15: Displacements under shear load, Option 1 Throughbolt ITS**

Anchor size		M6	M8	M10	M12
Shear load in cracked and non-cracked concrete	V [kN]	4,2	5,3	6,2	16,9
Displacements	$\delta_{V0}$ [mm]	2,8	2,9	2,5	3,6
	$\delta_{V\infty}$ [mm]	4,2	4,4	3,8	5,3

JCP Option 1 Throughbolt ITS

Performance  
Displacements under tension load and under shear load

Annex C14